

AT09 4G Quick Start Guide

Ver: EN 1.1
Date: 2022-12-20

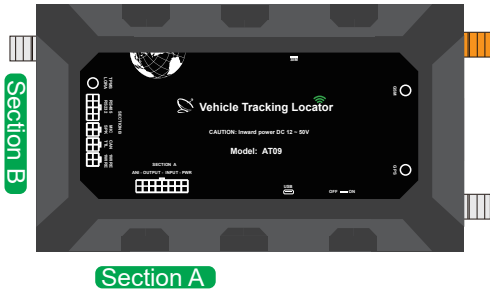

Please Make sure you have download below docs before you start:

1. AT09 online document support:
<https://en.totemtek.com/support/documents/gps-tracker-at09/>
 --- User manual, configurator, configuration manual.
2. AT09 online video reference:
<https://en.totemtek.com/category/blog/video/>

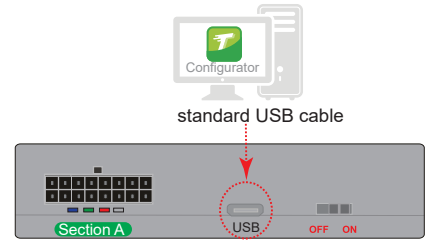
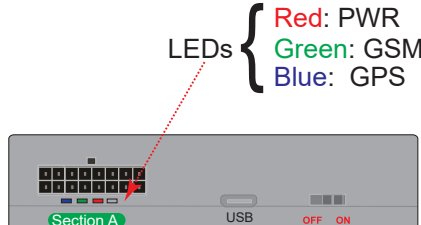
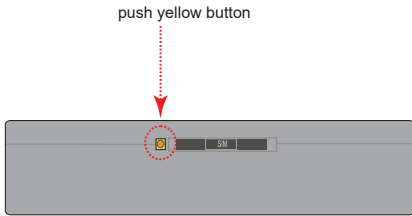

1 Use a pin to push the SIM drawer out, and put SIM inside the device.

2 Switch on the device switch to right side.

3 connect device to PC with configurator via micro USB.

4 Connect GSM and GPS antenna, put GPS antenna open to sky.

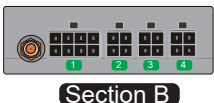

5 Connect desired IO port for data collection and finish the installation

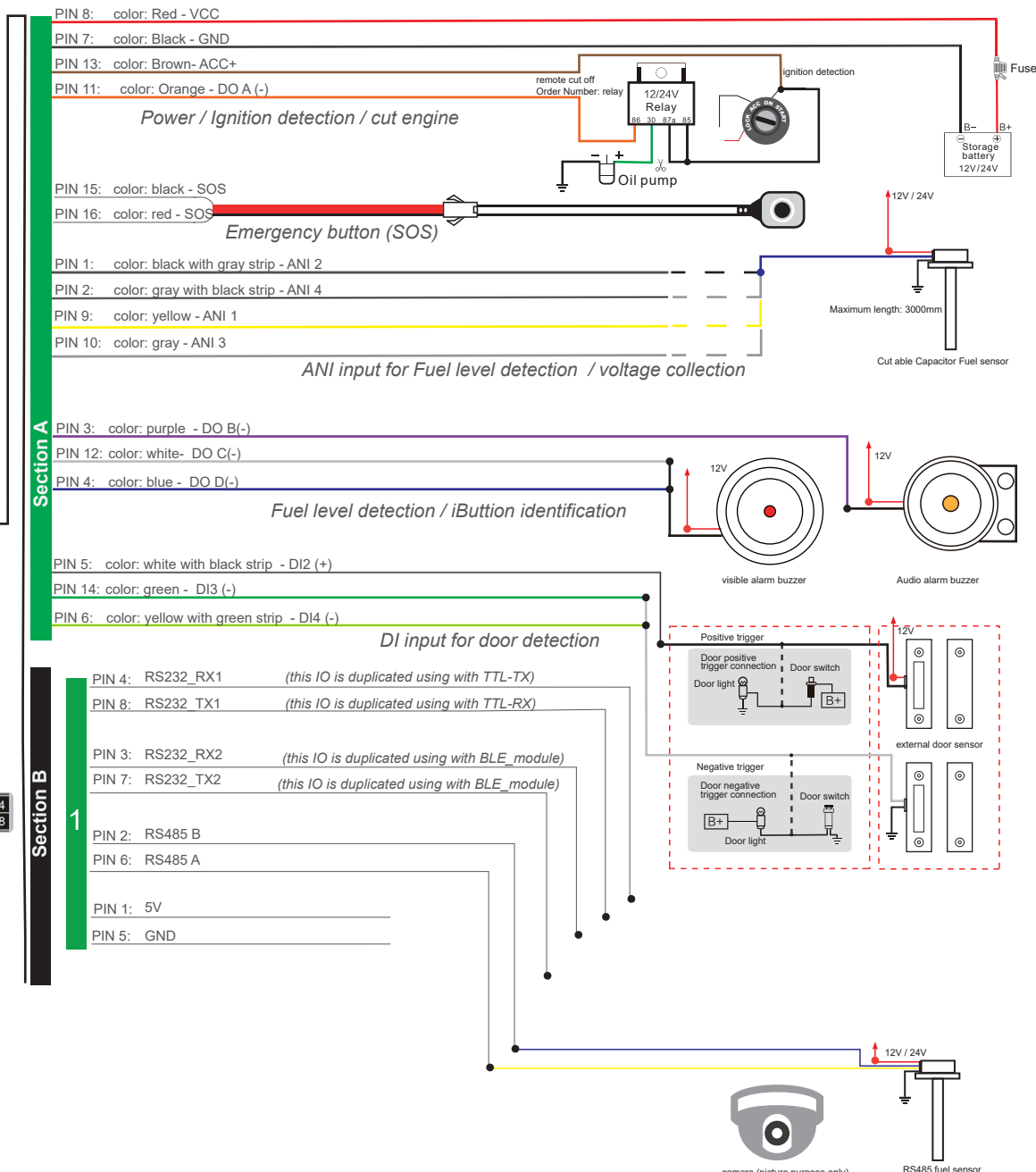

6

Connect the TPMS antenna if your device is TPMS version device.

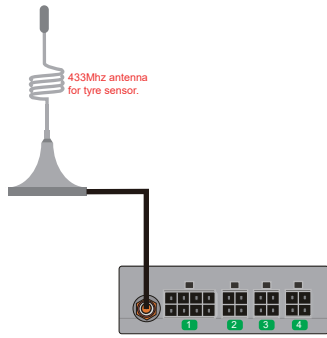

⚠ 433Mhz antenna for AT09 TPMS/LORA version only.

2

PIN 1: Speaker
 PIN 2: Speaker
 PIN 3: MIC
 PIN 4: MIC

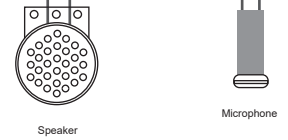

3

PIN 1: CAN_L
 PIN 2: CAN_H
 PIN 3: TTL_TX (this IO is duplicated using with RS232_TX1)
 PIN 4: TTL_RX (this IO is duplicated using with RS232_RX1)

4

PIN 1: 1-WIRE_1
 PIN 2: GND
 PIN 3: 1_WIRE_2
 PIN 4: 3V3

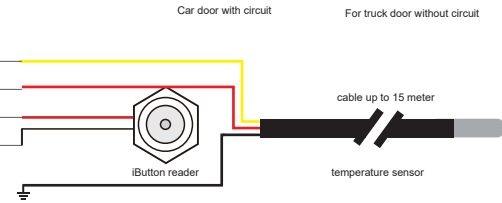

Section B



Standard package: AT09 4G device, section A cable, GPS antenna, GSM antenna, TPMS antenna (TPMS version only)



all the accessories mentioned here is NOT including in the standard package.



RS232 port can connect with different accessories with variant firmware version. Accessory will come with the proper connector to plug into AT09 device.



if the device is WIFI/BLE version, there is no extra external antenna required. Both device antenna is on board or has installed before out of the factory.